

DATA SHEET

GENERAL PURPOSE CHIP RESISTORS

RC0603 (Pb Free)
5%; 1%



Product specification – Aug 19, 2004 V.2



SCOPE

This specification describes RC0603 series chip resistors with lead-free terminations made by thick film process.

ORDERING INFORMATION

Part number is identified by the series, size, tolerance, packing type, temperature coefficient, taping reel and resistance value.

YAGEO ORDERING CODE

CTC CODE

RC0603 X X X XX XXXX L
 (1) (2) (3) (4) (5) (6)

(1) TOLERANCE

F = ±1%
 J = ±5%

(2) PACKAGING TYPE

R = Paper/PE taping reel

(3) TEMPERATURE COEFFICIENT OF RESISTANCE

– = Base on spec

(4) TAPING REEL

07 = 7 inch dia. Reel
 10 = 10 inch dia. Reel (not preferred)
 13 = 13 inch dia. Reel

(5) RESISTANCE VALUE

5R6, 56R, 560R, 5K6, 56K, 22M.

(6) RESISTOR TERMINATIONS

L = Lead free terminations (pure Tin)

ORDERING EXAMPLE

The ordering code of a RC0603 chip resistor, value 56 Ω with ±1% tolerance, supplied in 7-inch tape reel is: RC0603FR-0756RL.

NOTE

1. The “L” at the end of the code is only for ordering. On the reel label, the standard CTC will be mentioned an additional stamp “LFP”= lead free production.
2. Products with lead in terminations fulfil the same requirements as mentioned in this datasheet.
3. Products with lead in terminations will be phased out in the coming months (before July 1st, 2006)

MARKING

RC0603



E-24 series: 3 digits

First two digits for significant figure and 3rd digit for number of zeros

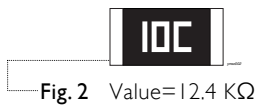

E-96 series: 3 digits for 0603 ±1% EIA-96 marking method

For 0603 ±1% E-24 series, one short bar under marking letter

For marking codes, please see EIA-marking code rules in data sheet “Chip resistors instruction”.

CONSTRUCTION

The resistors are constructed out of a high-grade ceramic body. Internal metal electrodes are added at each end and connected by a resistive paste. The composition of the paste is adjusted to give the approximate required resistance and laser cutting of this resistive layer that achieves tolerance trims the value. The resistive layer is covered with a protective coat and printed with the resistance value. Finally, the two external terminations (pure Tin) are added. See Fig. 4.

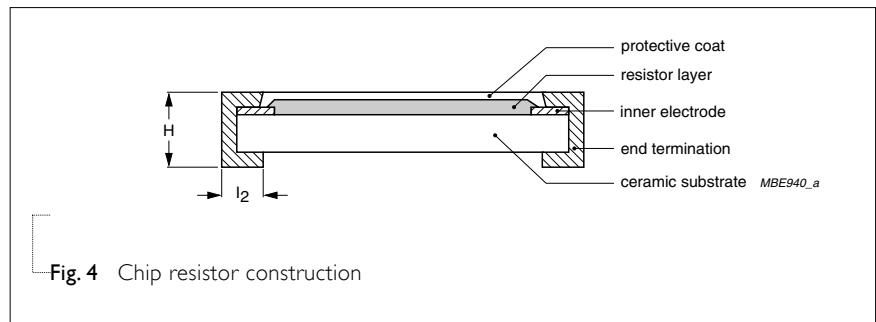

DIMENSIONS

Table I

| TYPE | RC0603 |
|---------------------|------------|
| L (mm) | 1.60 ±0.1 |
| W (mm) | 0.80 ±0.10 |
| H (mm) | 0.45 ±0.10 |
| l ₁ (mm) | 0.25 ±0.15 |
| l ₂ (mm) | 0.25 ±0.15 |

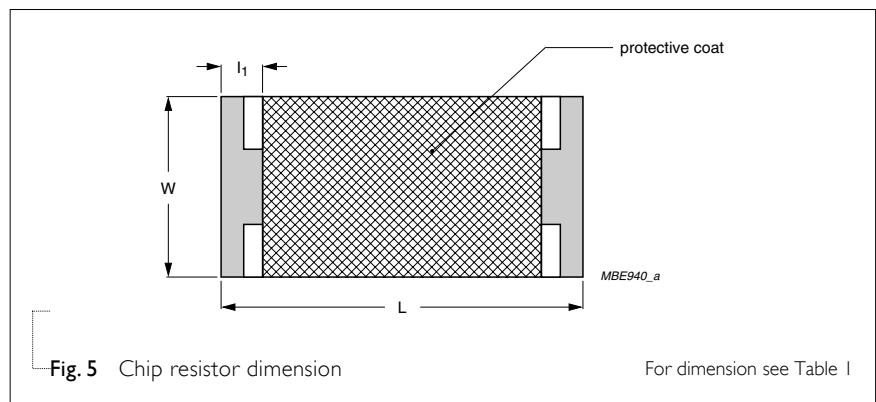

ELECTRICAL CHARACTERISTICS

Table 2

| CHARACTERISTICS | RC0603 1/10 W |
|---------------------------------|---------------------------------|
| Operating Temperature Range | -55 °C to +155 °C |
| Maximum Working Voltage | 50 V |
| Maximum Overload Voltage | 100 V |
| Dielectric Withstanding Voltage | 100 V |
| Resistance Range | 5% (E24) 1 Ω to 22 MΩ |
| | 1% (E96) 1 Ω to 10 MΩ |
| | Zero Ohm Jumper < 0.05 Ω |
| Temperature Coefficient | 10 Ω < R ≤ 10 MΩ ±100 ppm/°C |
| | R ≤ 10 Ω; R > 10 MΩ ±200 ppm/°C |
| Jumper Criteria | Rated Current 1.0 A |
| | Maximum Current 2.0 A |

FOOTPRINT AND SOLDERING PROFILES

For recommended footprint and soldering profiles, please see the special data sheet “Chip resistors mounting”.

ENVIRONMENTAL DATA

For material declaration information (IMDS-data) of the products, please see the separated info “Environmental data”.

PACKING STYLE AND PACKAGING QUANTITY

Table 3 Packing style and packaging quantity

| PRODUCT TYPE | PACKING STYLE | REEL DIMENSION | QUANTITY PER REEL |
|--------------|----------------------------|------------------------------|-------------------|
| RC0603 | Paper / PE Taping Reel (R) | 7" (178 mm) | 5,000 units |
| | | 10" (254 mm) / not preferred | 10,000 units |
| | | 13" (330 mm) | 20,000 units |

NOTE

1. For Paper/PE tape and reel specification/dimensions, please see the special data sheet “Packing” document.

FUNCTIONAL DESCRIPTION

POWER RATING

RC0603 rated power at 70°C is 1/10 W

RATED VOLTAGE

The DC or AC (rms) continuous working voltage corresponding to the rated power is determined by the following formula:

$$V = \sqrt{P \times R}$$

Where

V=Continuous rated DC or AC (rms) working voltage (V)

P=Rated power (W)

R=Resistance value (Ω)

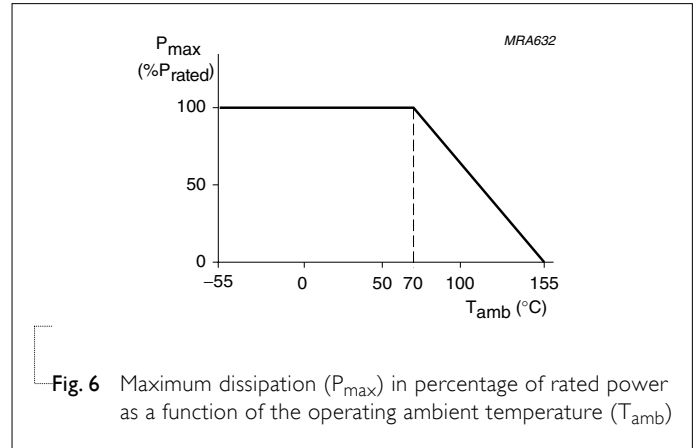

PULSE LOADING CAPABILITIES

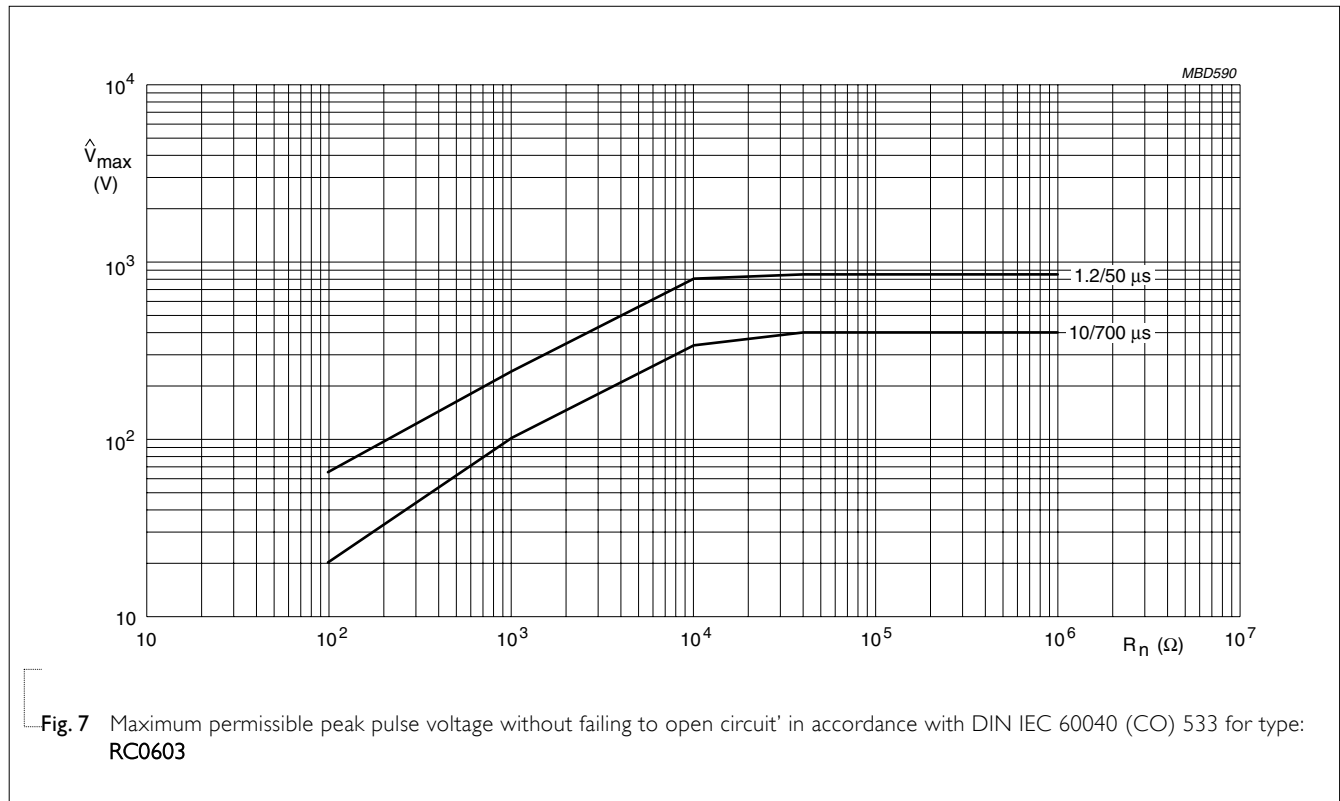

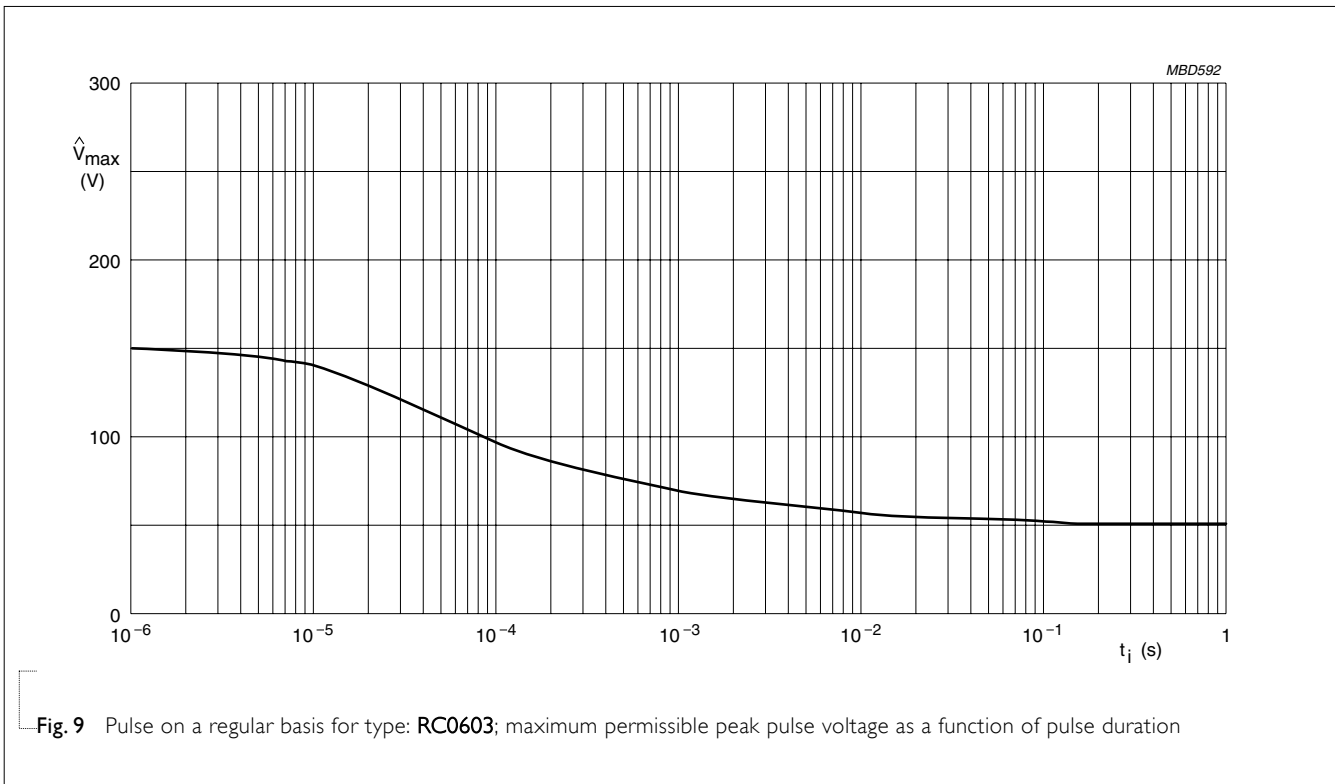
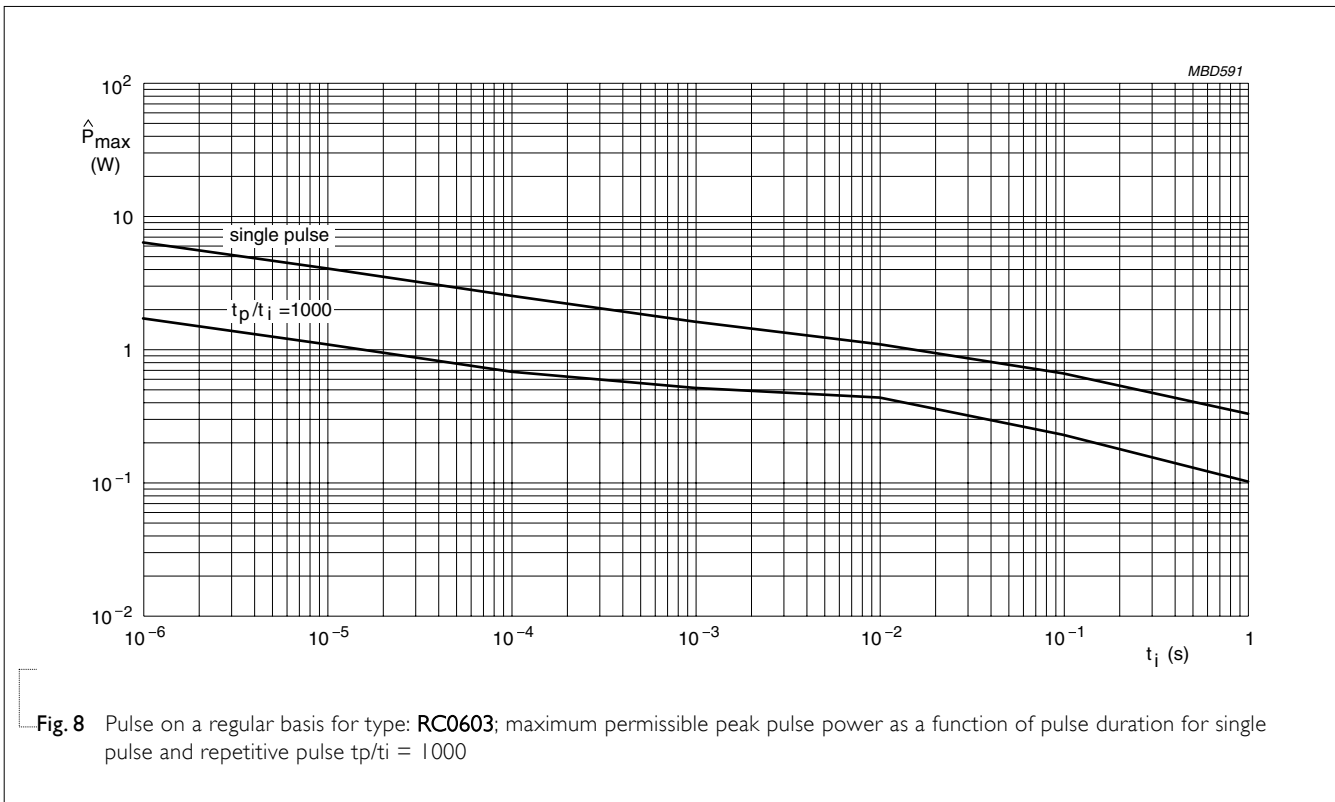

TESTS AND REQUIREMENTS

Table 4 Test condition, procedure and requirements

| TEST | TEST METHOD | PROCEDURE | REQUIREMENTS |
|--|---|--|--|
| Temperature Coefficient of Resistance (T.C.R.) | MIL-STD-202F-method 304; | At +25/-55 °C and +25/+125 °C | Refer to table 2 |
| | JIS C 5202-4.8 | <p>Formula:</p> $T.C.R = \frac{R_2 - R_1}{R_1(t_2 - t_1)} \times 10^6 \text{ (ppm/°C)}$ <p>Where $t_1 = +25 \text{ °C}$ or specified room temperature $t_2 = -55 \text{ °C}$ or +125 °C test temperature $R_1 =$resistance at reference temperature in ohms $R_2 =$resistance at test temperature in ohms</p> | |
| Thermal Shock | MIL-STD-202F-method 107G; IEC 60115-1 4.19 | At -65 (+0/-10) °C for 2 minutes and at +155 (+10/-0) °C for 2 minutes; 25 cycles | ±(0.5%+0.05 Ω) for 1% tol. ±(1.0%+0.05 Ω) for 5% tol. |
| Low Temperature Operation | MIL-R-55342D-Para 4.7.4 | At -65 (+0/-5) °C for 1 hour; RCWV applied for 45 (+5/-0) minutes | ±(0.5%+0.05 Ω) for 1% tol . ±(1.0%+0.05 Ω) for 5% tol. No visible damage |
| Short Time Overload | MIL-R-55342D-Para 4.7.5; IEC 60115-1 4.13 | 2.5 × RCWV applied for 5 seconds at room temperature | ±(1.0%+0.05 Ω) for 1% tol. ±(2.0%+0.05 Ω) for 5% tol. No visible damage |
| Insulation Resistance | MIL-STD-202F-method 302; IEC 60115-1 4.6.1.1 | RCOV for 1 minute <u>Type</u> RC0603 <u>Voltage (DC)</u> 100 V | ≥10 GΩ |
| Dielectric Withstand Voltage | MIL-STD-202F-method 301; IEC 60115-1 4.6.1.1 | Maximun voltage (V_{rms}) applied for 1 minute <u>Type</u> RC0603 <u>Voltage (AC)</u> 100 V_{rms} | No breakdown or flashover |
| Resistance to Soldering Heat | MIL-STD-202F-method 210C; IEC 60115-1 4.18 | Unmounted chips; 260 ±5 °C for 10 ±1 seconds | ±(0.5%+0.05 Ω) for 1% tol. ±(1.0%+0.05 Ω) for 5% tol. No visible damage |
| Life | MIL-STD-202F-method 108A; IEC 60115-1 4.25.1 | At 70±2 °C for 1,000 hours; RCWV applied for 1.5 hours on and 0.5 hour off | ±(1%+0.05 Ω) for 1% tol. ±(3%+0.05 Ω) for 5% tol. |

| TEST | TEST METHOD | PROCEDURE | REQUIREMENTS | | | | | | | | | | | | | | |
|---------------------------------|---|--|---|-----------------|-------|-----------|-------|------------------|-------|------------------|-------|--------------------|-------|-------------------|-------|------------------|-------|
| Solderability | MIL-STD-202F-method 208A; IEC 60115-1 4.17 | Solder bath at 245±3 °C Dipping time: 2±0.5 seconds | Well tinned (≥95% covered) No visible damage | | | | | | | | | | | | | | |
| Bending Strength | JIS C 5202.6.14; IEC 60115-1 4.15 | Resistors mounted on a 90 mm glass epoxy resin PCB (FR4) Bending: 5 mm | ±(1.0%+0.05 Ω) for 1% tol. ±(1.0%+0.05 Ω) for 5% tol. No visible damage | | | | | | | | | | | | | | |
| Resistance to Solvent | MIL-STD-202F-method 215; IEC 60115-1 4.29 | Isopropylalcohol (C ₃ H ₇ OH) or dichloromethane (CH ₂ Cl ₂) followed by brushing | No smeared | | | | | | | | | | | | | | |
| Noise | JIS C 5202 5.9; IEC 60115-1 4.12 | Maximum voltage (V _{rms}) applied. | <table border="1"> <thead> <tr> <th>Resistors range</th> <th>Value</th> </tr> </thead> <tbody> <tr> <td>R < 100 Ω</td> <td>10 dB</td> </tr> <tr> <td>100 Ω ≤ R < 1 KΩ</td> <td>20 dB</td> </tr> <tr> <td>1 KΩ ≤ R < 10 KΩ</td> <td>30 dB</td> </tr> <tr> <td>10 KΩ ≤ R < 100 KΩ</td> <td>40 dB</td> </tr> <tr> <td>100 KΩ ≤ R < 1 MΩ</td> <td>46 dB</td> </tr> <tr> <td>1 MΩ ≤ R ≤ 22 MΩ</td> <td>48 dB</td> </tr> </tbody> </table> | Resistors range | Value | R < 100 Ω | 10 dB | 100 Ω ≤ R < 1 KΩ | 20 dB | 1 KΩ ≤ R < 10 KΩ | 30 dB | 10 KΩ ≤ R < 100 KΩ | 40 dB | 100 KΩ ≤ R < 1 MΩ | 46 dB | 1 MΩ ≤ R ≤ 22 MΩ | 48 dB |
| Resistors range | Value | | | | | | | | | | | | | | | | |
| R < 100 Ω | 10 dB | | | | | | | | | | | | | | | | |
| 100 Ω ≤ R < 1 KΩ | 20 dB | | | | | | | | | | | | | | | | |
| 1 KΩ ≤ R < 10 KΩ | 30 dB | | | | | | | | | | | | | | | | |
| 10 KΩ ≤ R < 100 KΩ | 40 dB | | | | | | | | | | | | | | | | |
| 100 KΩ ≤ R < 1 MΩ | 46 dB | | | | | | | | | | | | | | | | |
| 1 MΩ ≤ R ≤ 22 MΩ | 48 dB | | | | | | | | | | | | | | | | |
| Humidity (steady state) | JIS C 5202 7.5; IEC 60115-8 4.24.8 | 1,000 hours; 40±2 °C; 93(+2/-3)% RH RCWV applied for 1.5 hours on and 0.5 hour off | ±(0.5%+0.05 Ω) for 1% tol. ±(2.0%+0.05 Ω) for 5% tol. | | | | | | | | | | | | | | |
| Leaching | EIA/IS 4.13B; IEC 60115-8 4.18 | Solder bath at 260±5 °C Dipping time: 30±1 seconds | No visible damage | | | | | | | | | | | | | | |
| Intermittent Overload | JIS C 5202 5.8 | At room temperature; 2.5 × RCWV applied for 1 second on and 25 seconds off; total 10,000 cycles | ±(1.0%+0.05 Ω) for 1% tol. ±(2.0%+0.05 Ω) for 5% tol. | | | | | | | | | | | | | | |
| Resistance to Vibration | On request | On request | | | | | | | | | | | | | | | |
| Moisture Resistance Heat | MIL-STD-202F-method 106F; IEC 60115-1 4.24.2 | 42 cycles; total 1,000 hours Shown as Fig. 10 | ±(0.5%+0.05Ω) for 1% tol. ±(2.0%+0.05Ω) for 5% tol. No visible damage | | | | | | | | | | | | | | |

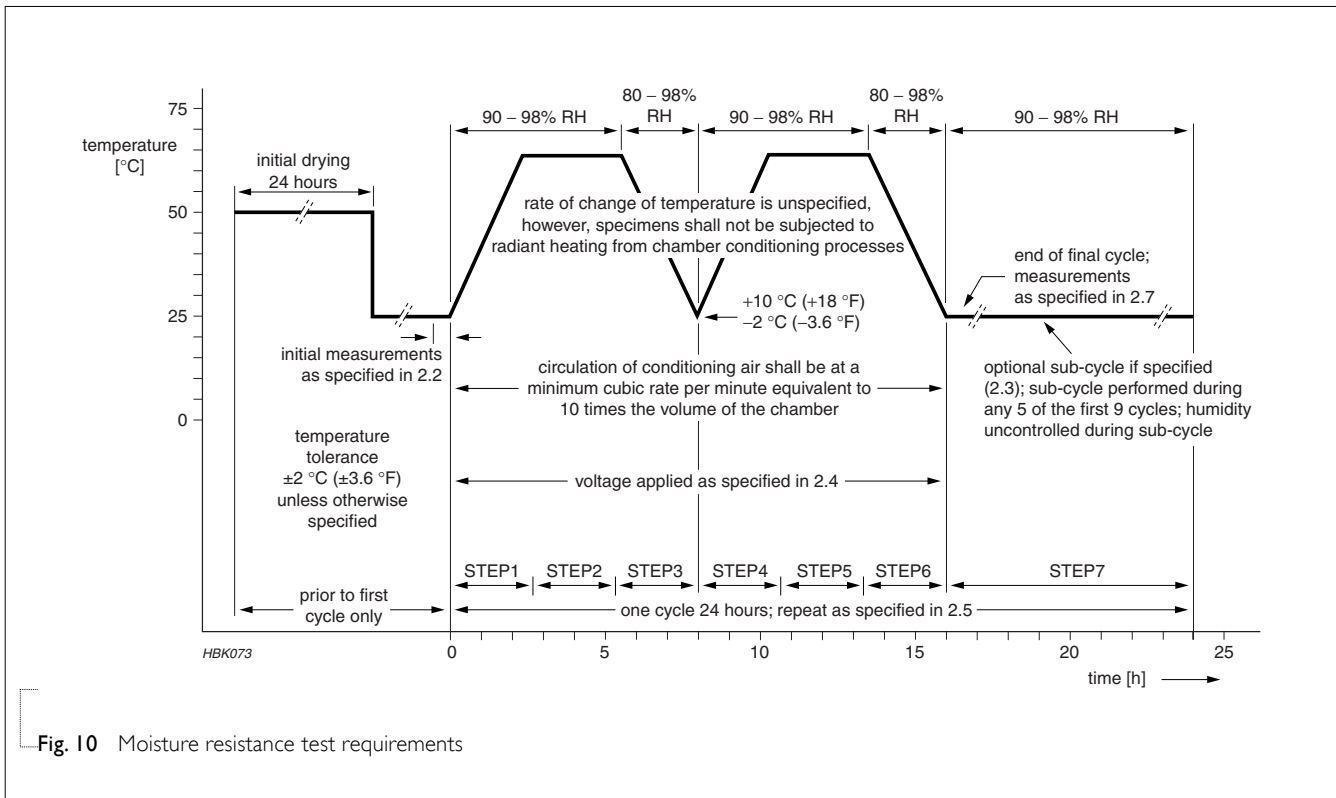

Fig. 10 Moisture resistance test requirements

REVISION HISTORY

| REVISION | DATE | CHANGE NOTIFICATION | DESCRIPTION |
|-----------|---------------|---------------------|---|
| Version 0 | Nov. 07, 2003 | - | - First issue of this specification |
| Version 1 | Aug 02, 2004 | - | - Test method and procedure updated - PE tape added (paper tape will be replaced by PE tape) |
| Version 2 | Aug 19, 2004 | - | - |